

**CROSS SECTION OF HEAD**

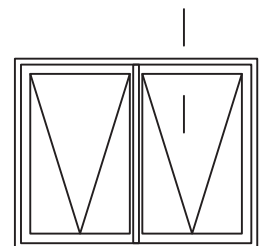

**CROSS SECTION OF JAMB**

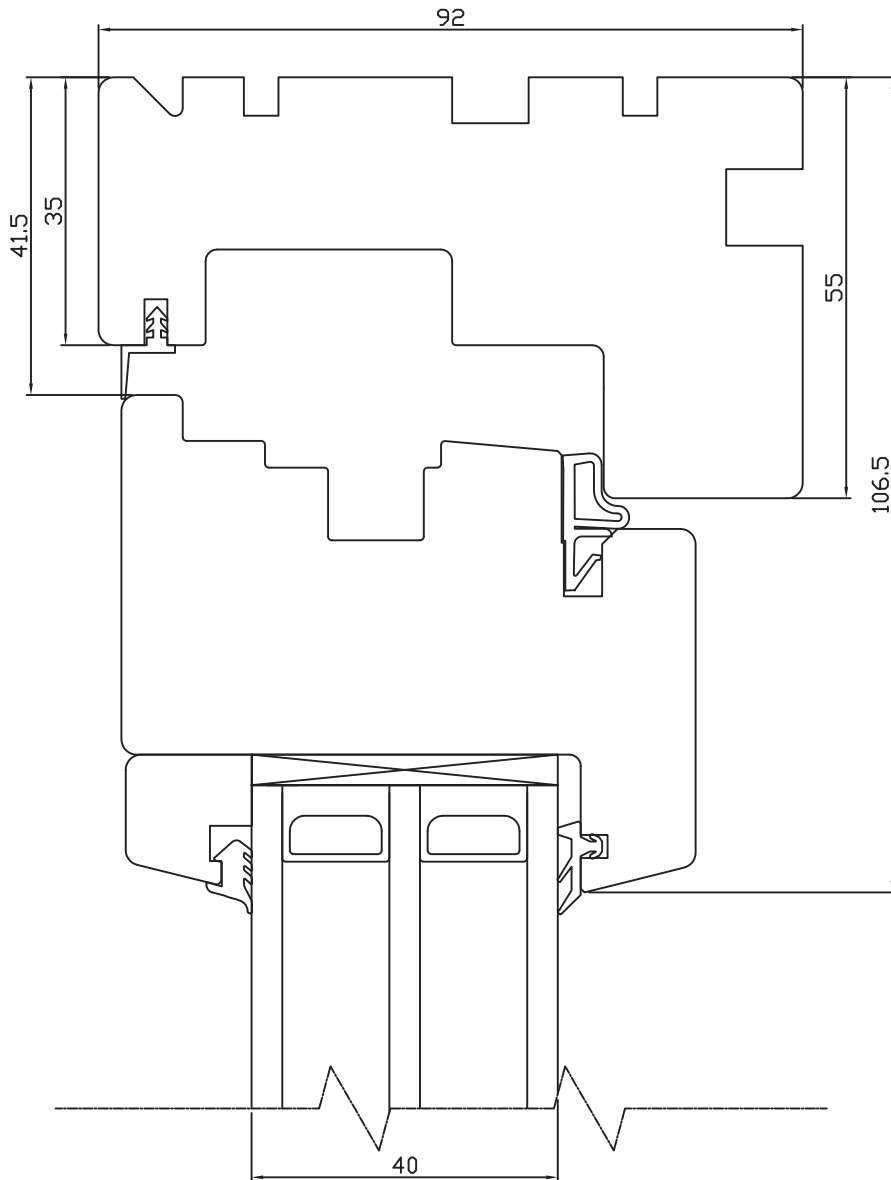
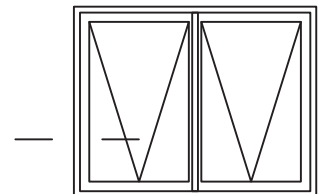
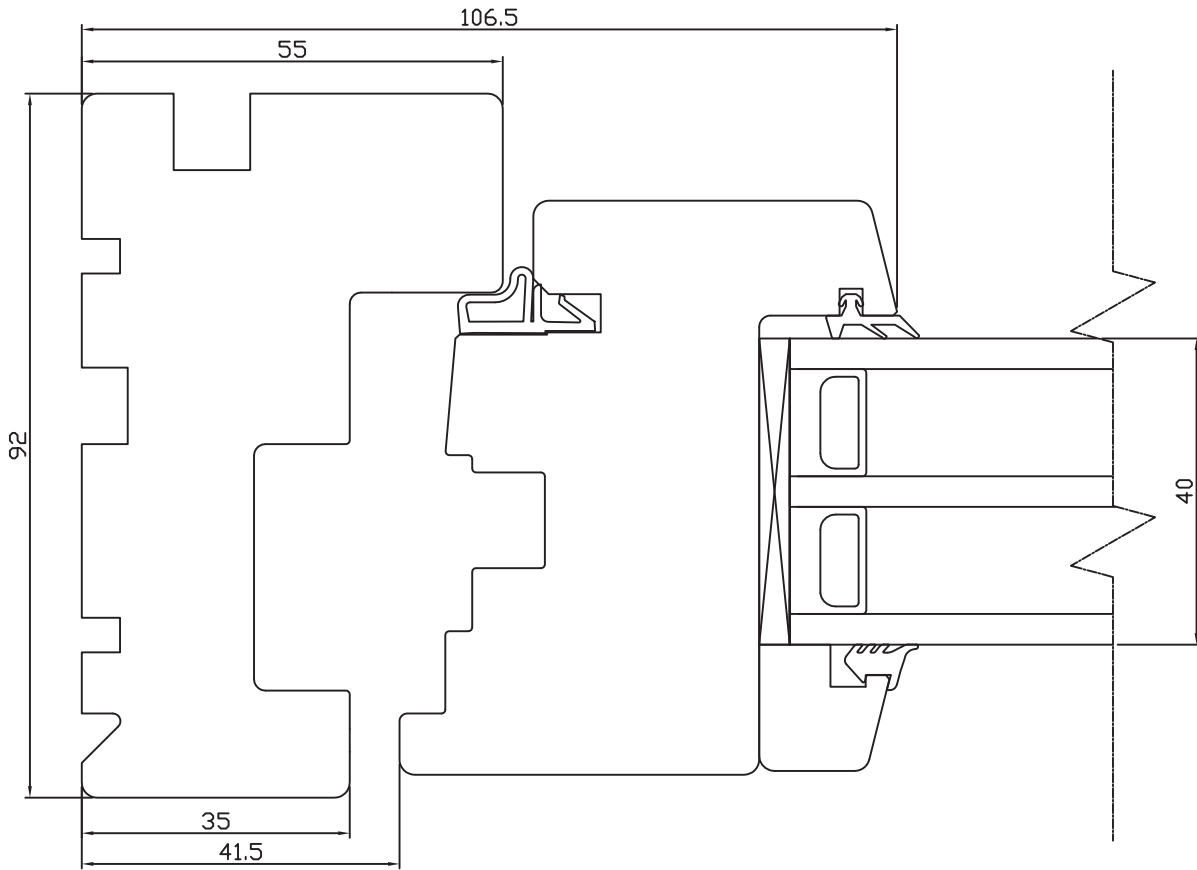

**CROSS SECTION OF SILL**

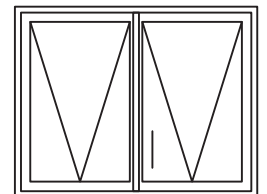
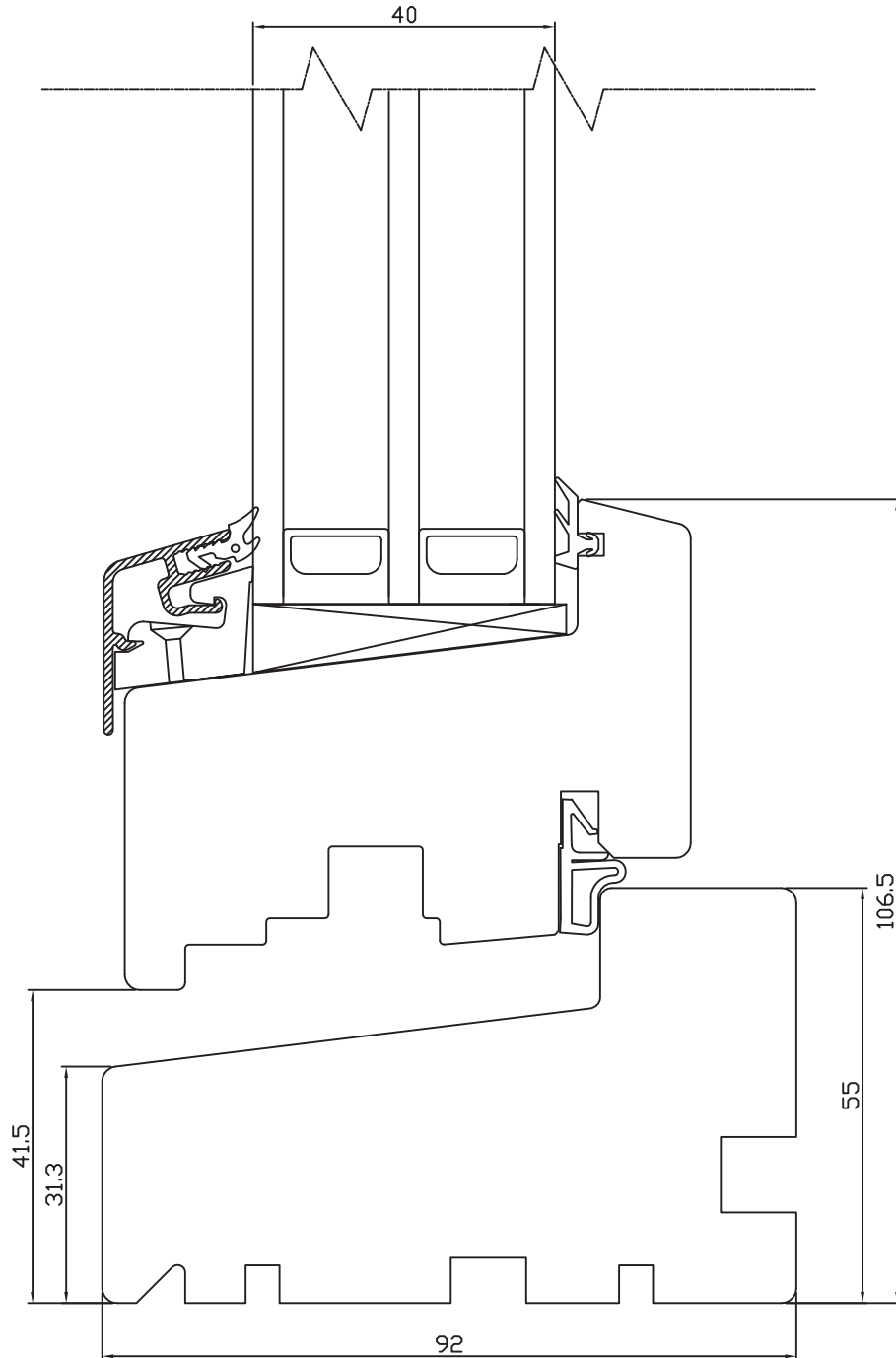

**CROSS SECTION OF 56mm GLAZING BARS**

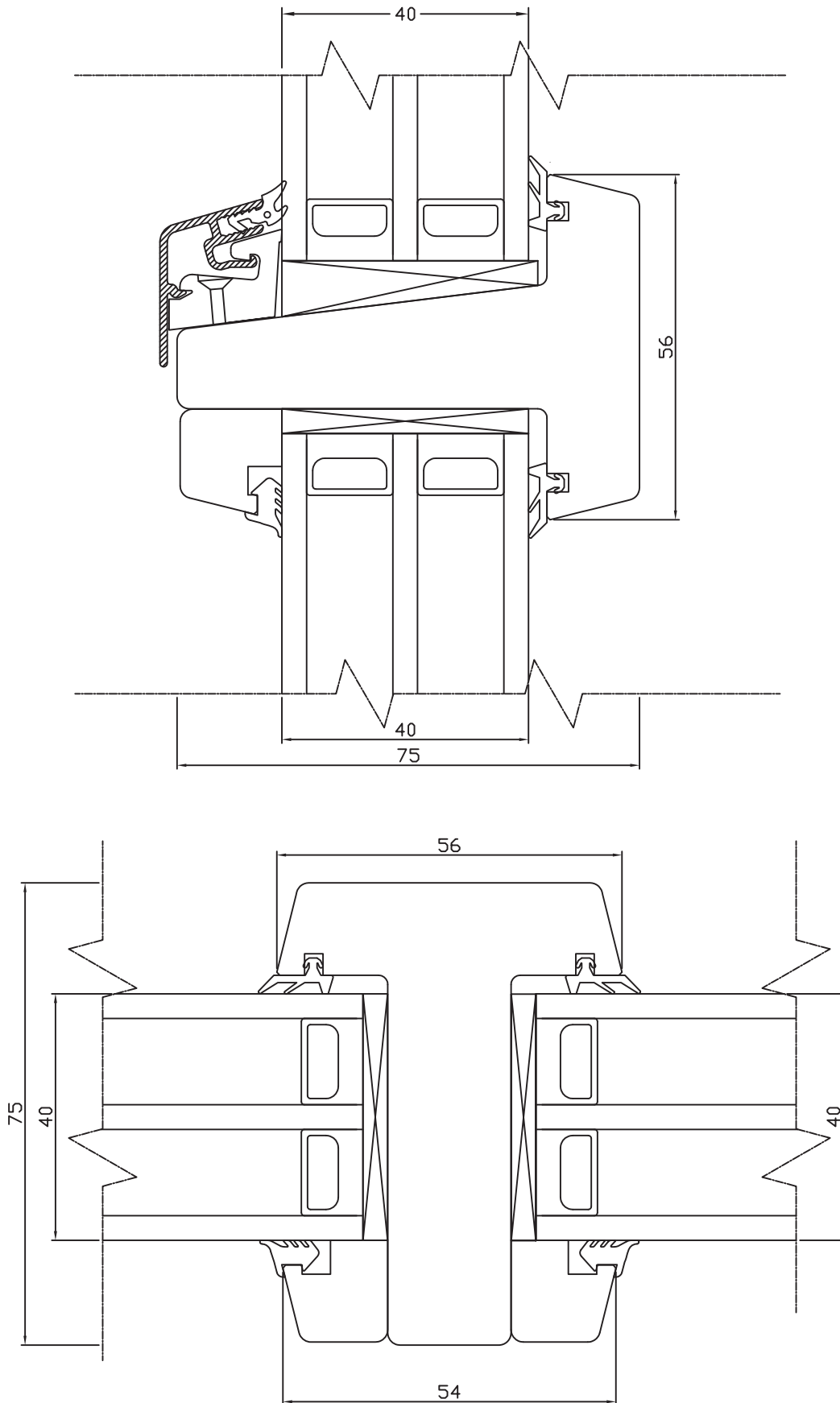

drawing subject to change without notice

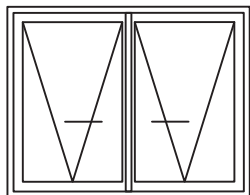
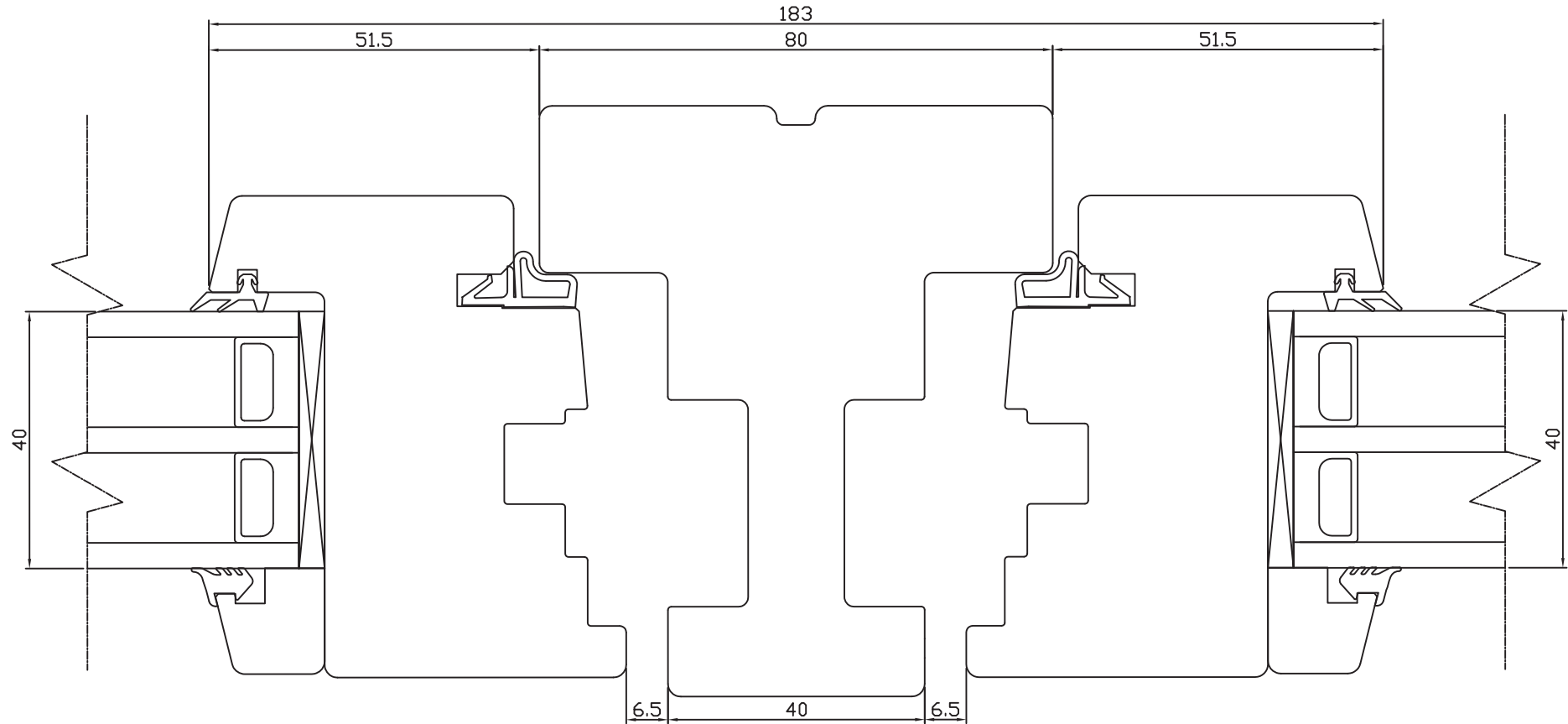

**NORRSKEN**

5 The Axium Centre  
Dorchester Road  
Poole  
Dorset  
BH16 6FE  
UK

**NORRSKEN OUTWARD OPENING TIMBER TRIPLE  
GLAZED WINDOW**

**CROSS SECTION OF MULLION**

Drawing Number

OOTTG.4

Scale

1:1

**CROSS SECTION OF REBATED DOUBLE CASEMENT**

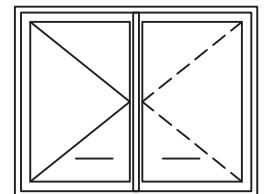
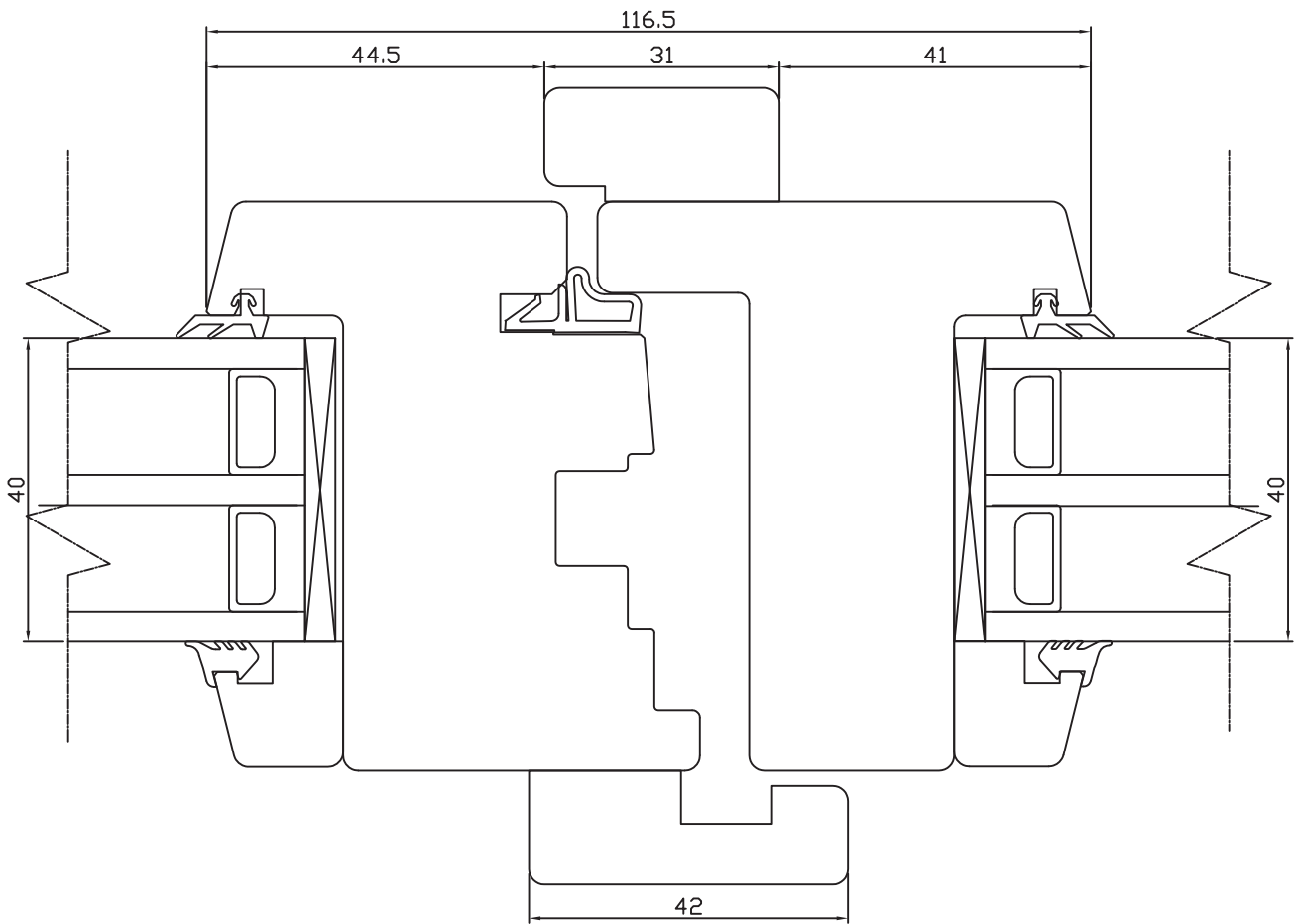

**CROSS SECTION OF TRANSOM**

